

ENGINEERING DESIGN SOLUTION



CHEMTED LLC



EXCELLENCE AND INNOVATION BUILT INTO EVERY DESIGN

INTRODUCTION



- We take pride in introducing “CHEMTED” as a leading company of superior quality in Process Engineering Design of Oil & Gas Sector, Industrial Refrigeration, Marine Refrigeration and Process Chemical Industries. Since our inception, we are constantly providing new solutions to meet the requirement of rapidly advancing technology.



INNOVATIVE ENGINEERING SOLUTIONS

CHEMTED LLC



VISION



- To establish CHEMTED as an EXPERT in Design Engineering by using latest technologies at optimum cost with 100% customer satisfaction.



INNOVATIVE ENGINEERING SOLUTIONS

MISSION



- **CHEMTED's** Principal Mission is to deliver services of the highest caliber; to actively contribute towards the success of our clients. Our company desires to foster long term partnering relationships with our clients.
- **CHEMTED** Stresses superior results. We therefore apply hard word to effective strategies in ensuring the success of our projects. We understand that our success depends on close collaboration with our clients, to set objectives, develop analytical studies and conduct periodic reviews to measure our results against our objectives.

OUR MISSION

INNOVATIVE ENGINEERING SOLUTIONS

CHEMTED OPERATIONAL PHILOSOPHY



INNOVATIVE ENGINEERING SOLUTIONS

CHEMTED'S PRIVACY POLICY

CHEMTED LLC
Innovative Engineering Solutions



- **CHEMTED** knows that you care how your information is used and shared, and we appreciate your trust that we will do so carefully and sensibly. As there is always some risk in the transmission of data over the Internet through emails etc. But we deem appropriate, we use a combination of industry standard security measures to protect your information.
- Customer's identifiable information or any proprietary design or document shared with us at any stage is kept secure in a way that only authorized employees, agents and contractors (who have agreed to keep information secure and confidential) have access to this information.
- **Contact Us** If you have any questions or comments about privacy on this website, please send us an e-mail at info@chemted.com

Note: The privacy practices set forth in this privacy policy are for our website or any information proprietary design or document exchanged by our valued customer, vendors or any interested parties.

INNOVATIVE ENGINEERING SOLUTIONS

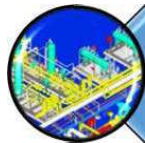

Engineering Design Services

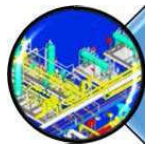

Products Manufacturing



Supply Chain Services



Training & Development

SCOPE OF OUR SERVICES

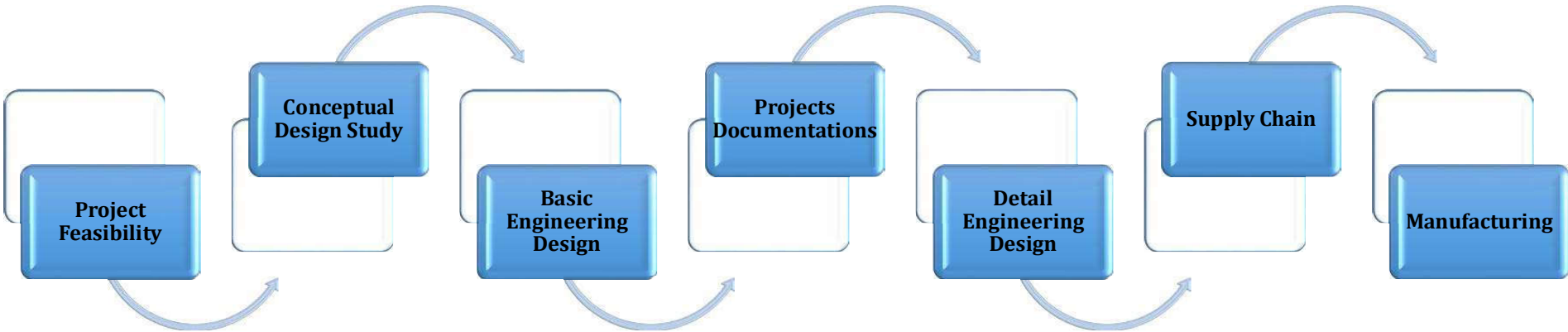

INNOVATIVE ENGINEERING SOLUTIONS

SECTORS OF OUR SERVICES

CHEMTED LLC
Innovative Engineering Solutions



OIL & GAS



**PETROCHEMICAL
INDUSTRIES**



**INDUSTRIAL
REFRIGERATION**



**CHEMICAL PROCESS
INDUSTRIES**

INNOVATIVE ENGINEERING SOLUTIONS

ORGANIZATION CHART

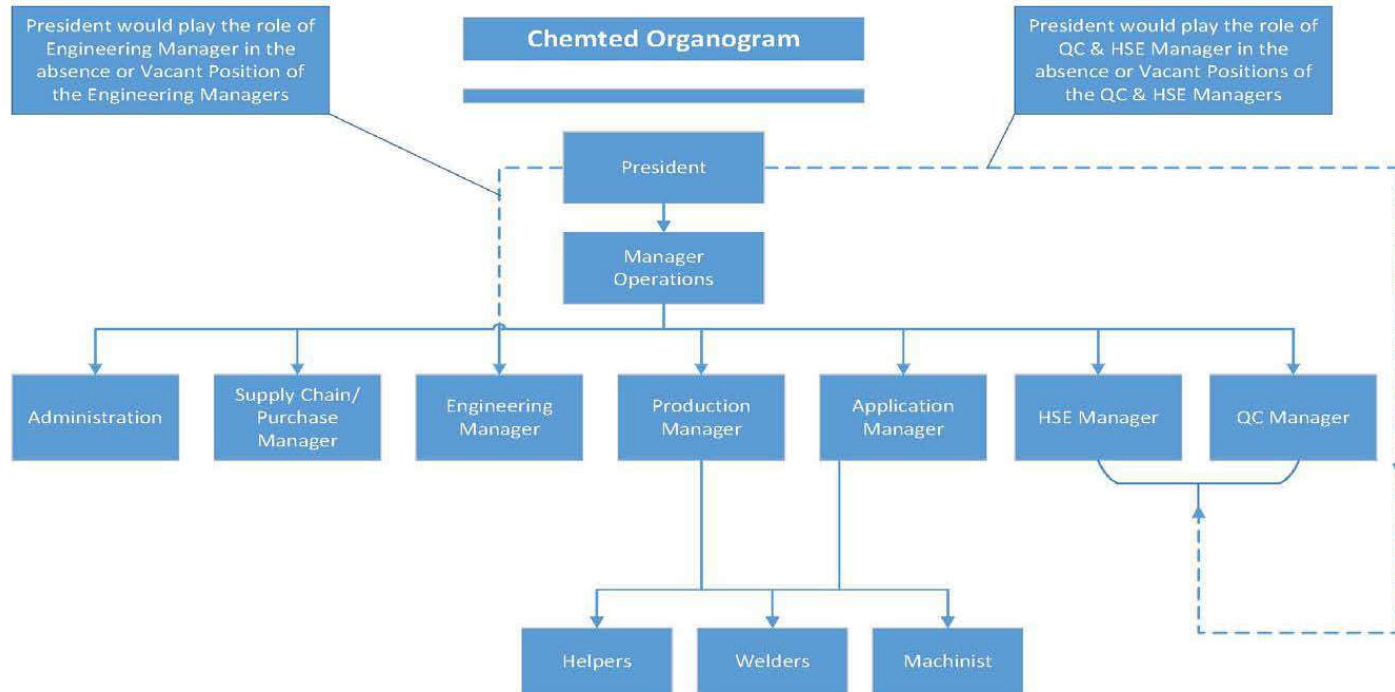

AREAS OF DESIGN SERVICES

CHEMTEC LLC
Innovative Engineering Solutions



Process Engineering Services

- **General Services:**
 - Project definition and scope development
 - Conceptual to appropriation cost estimating
 - Piping and Instrument Diagram (P&ID) development
 - Equipment and instrument specifications
 - Piping, equipment and instrument layout and detailing
 - Plant debottlenecking and process optimization
- **Process Simulations Services as follows:**
 - Hydrocarbon Dew point Control
 - Dehydration Plants
 - Gas Recovery Plants
 - Gas Sweetening Plants
 - Scrubber Packages
 - Separator Packages like 2 & 3 Phase separators, Heavy crude separators & Test separators
 - Tail Gas Clean-up Packages
 - Chemical Injection Package
 - Industrial Refrigeration Systems

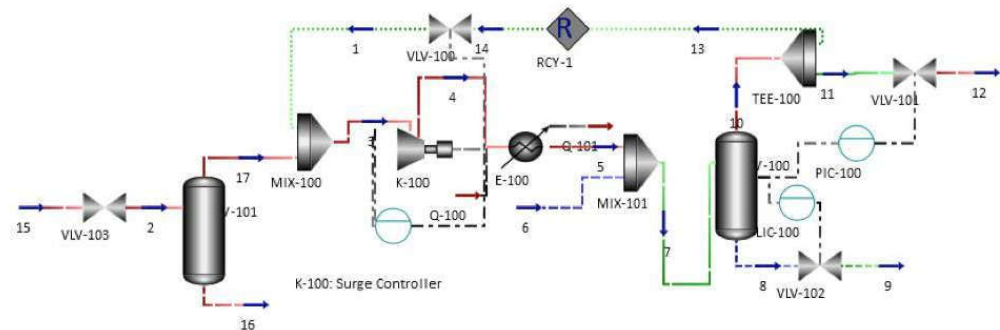

INNOVATIVE ENGINEERING SOLUTIONS

AREAS OF DESIGN SERVICES

CHEMTED LLC
Innovative Engineering Solutions



Static Equipment Services

- **Pressure Vessels:** We design pressure vessels per ASME Sec.VIII,Div.1, PD-5500 and CRN Etc.
- Receivers
- Economizers
- Accumulators
- Intercoolers
- Oil Separators
- Oil Filters
- Oil Pots
- Scrubbers
- Surge Drums



INNOVATIVE ENGINEERING SOLUTIONS

AREAS OF DESIGN SERVICES



Static Equipment Services

- **Shell & Tube Heat Exchangers & PHE:** Per ASME, TEMA & Per specifications of the costumer:
- Evaporators
- Flooded Chillers
- Condensers
- Feed/Bottom Exchanger
- Sub Coolers
- Desuperheaters
- Oil Coolers
- Reboilers
- Thermosyphon
- Gas-to-Gas Heat Exchangers
- Gas-to-Liquid Heat Exchangers

CHEMTED LLC
Innovative Engineering Solutions

CHEMTED IS VERSATILE & HAVE UNIQUE PROFESSIONALS FOR THERMAL DESIGN & FABRICATION OF THE SHELL & TUBE HEAT EXCHANGERS.

S&T HEAT EXCHANGERS

WWW.CHEMTED.COM
+1 (214) 680 6013

INNOVATIVE ENGINEERING SOLUTIONS

AREA OF DESIGN SERVICES

CHEMTED LLC
Innovative Engineering Solutions



Design for Piping, supports and flexibility analysis

- **Piping Design:**
- Design of In-Plant Piping for Petrochemical, Chemical, Crude / Gas and Utilities lines according to ASME/ANSI/B31.1/31.3/ B31.8, and project specifications other related Standards.

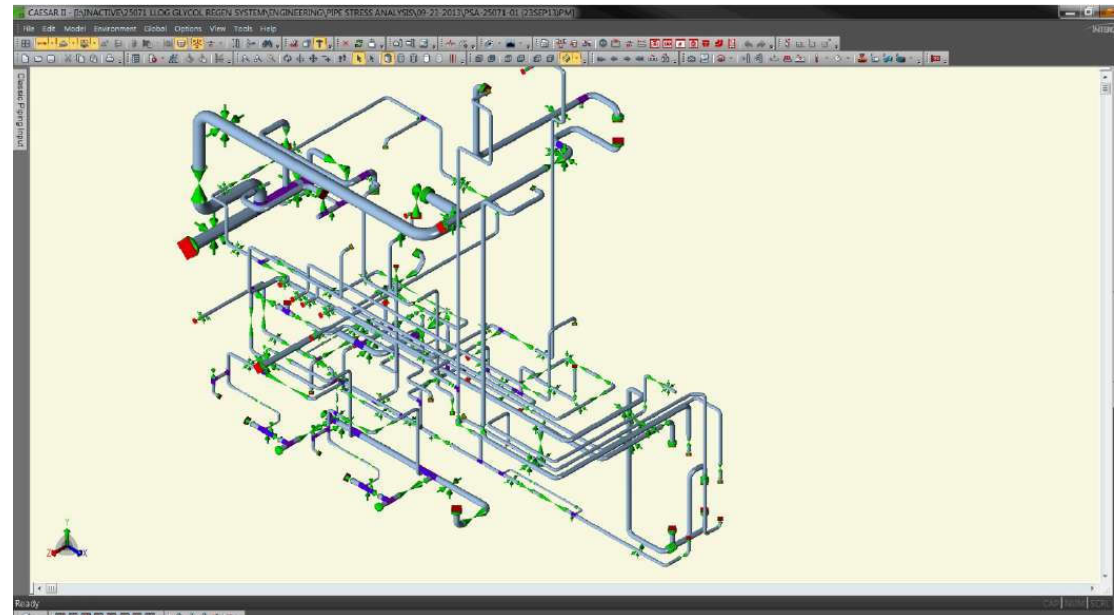

INNOVATIVE ENGINEERING SOLUTIONS

AREA OF DESIGN SERVICES

CHEMTEC LLC
Innovative Engineering Solutions



Steel Structure

- Skid Packages Structure
- Static Equipment Structure
- Boiler Complete Structure
- Piping Rack & Pipe Supports
- Pre-Engineering Buildings
- Flare Stacks etc.



INNOVATIVE ENGINEERING SOLUTIONS

AREAS OF DESIGN SERVICES

CHEMTEC LLC
Innovative Engineering Solutions



Other Services

- **Rotary Equipment**
- Data sheet, Specifications & Material Requisitions preparation (for RFQ). Bid Clarifications (TCLs), Technical Bid evaluation (TBEs) and Report, Vendor document review, Vendor-shop review and evaluations, FAT/SATs attendance for Rotary & Package equipment including performance review, noise & vibration studies.
- **Reports, method statements and construction procedures**
- **Design of Consumer products**
- **Procurement Support (Requisitions, Technical evaluation etc.)**
- **Consultancy services for fabrication and manufacturing**
- **Preparation of Customer Specifications, Process Datasheets, Pre-BOM & RFQ Documentations**
- **Consultancy services for hydrotest, Pre-commissioning, Commissioning**

INNOVATIVE ENGINEERING SOLUTIONS

Engineering Software:

- Aspen Plus
- HTRI
- PV Elite
- Codeware Compress
- CAESAR
- AutoCAD
- CADWorkx
- STAAD Pro
- RAM Connection
- Ansys Workbench
- Nozzle Pro

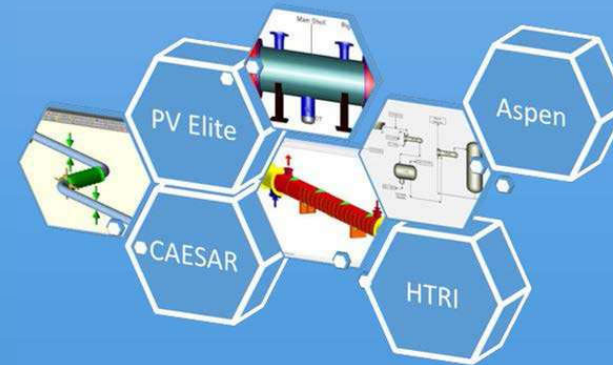

PRODUCTS



Skid Packages

We provide engineering services & manufacturing skid based systems that includes followings

- Gas Compression Packages
- Oil Removal Packages
- Natural Gas processing Packages which includes
- Dehydration
- Fractionation
- Condensate Stabilization
- Amine Sweetening
- Cryogenic Processing
- Control System
- Dew Point Control
- Water Chillers
- Process Gas Chilling
- Air or Nitrogen Chilling
- Glycol Chillers
- NGL Recovery System
- Cascade Refrigerant System
- Food Processing & Storage Refrigerant System

INNOVATIVE ENGINEERING SOLUTIONS

PRODUCTS



Static Equipment

We at Chemted always ensure that our thermal selection & production would be cost effective in regarding to the capital cost & as well as in operating cost.

- Evaporators
- Condensers
- Refrigeration Condensers
- Pre-Coolers
- Receivers
- Economizers
- Accumulators
- Oil Separators
- Oil Filters
- Reboilers
- Flooded, Chillers
- Fixed tube sheet oil coolers,
- U-Tube and Removable bundle heat exchangers
- Oil Coolers
- Oil Pots
- Scrubbers
- Surge Drums
- Inter-Coolers
- After-Coolers
- Product Coolers

INNOVATIVE ENGINEERING SOLUTIONS

PRODUCTS



Steel Structure

Some of the steel structure we commonly offer for production are:

- Skid Packages Structure
- Static Equipment Structure
- Boiler Complete Structure
- Piping Rack & Pipe Supports
- Pre-Engineering Buildings
- Flare Stacks etc.

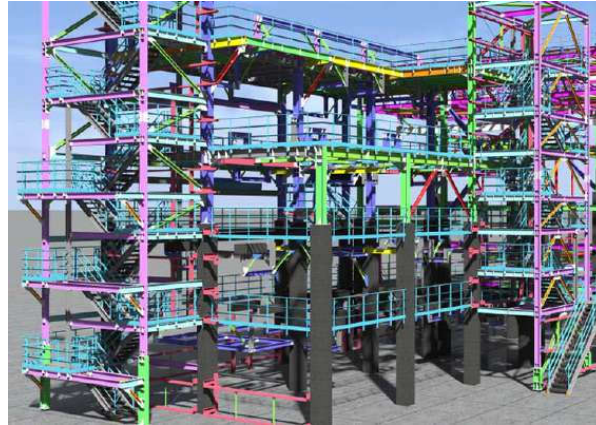

INNOVATIVE ENGINEERING SOLUTIONS

AREA

CHEMTED LLC
Innovative Engineering Solutions



Description	Area, Sq ft
ASME Shop	53,000
Office Building	31,000
Non-Coded Manufacturing Shop	39,000
Machine Shop	25,000
Other Buildings	28,000
Open Area for Future Extensions	194,000
Total Area	370,000

INNOVATIVE ENGINEERING SOLUTIONS

OUR WORKSHOP

We have state of the art facilities in the covered area of Approx. 53,000 sq. ft.

Here are some of the pictures

ASME SHOP



INNOVATIVE ENGINEERING SOLUTIONS

OUR WORKSHOP

Office Building



INNOVATIVE ENGINEERING SOLUTIONS

OUR WORKSHOP

Non-Coded Manufacturing Shop



INNOVATIVE ENGINEERING SOLUTIONS

OUR WORKSHOP

Machine Shop



INNOVATIVE ENGINEERING SOLUTIONS

OUR WORKSHOP- MACHINERY LIST



Description	Capacity	Quantity
Over Head Cranes	10 Tons	3
Over Head Cranes	5 Tons	1
Fork Lifter- Toyota	10 Tons	2
Fork Lifter- Clark	6 Tons	2
Fork Lifter- Hyundai	6 Tons	1
Tractor	4 Tons	1

OUR WORKSHOP- MACHINERY LIST



Description	Capacity	Quantity
Press Brake	230 Tons	1
Press Brake	350 Tons	1
Plasma Cutting Machine	40 Ft	1
Plasma Cutting Machine	20 Ft	1
Sub-Arc Welding Machine	6 Ft Manipulator	2
Rolling Machine	3" Thk	1

INNOVATIVE ENGINEERING SOLUTIONS

OUR WORKSHOP- MACHINERY LIST



Description	Capacity	Quantity
Auto Gas Cutting Machine	up to 2.5"	2
Copy Gas Cutting Machine	up to 2.5"	1
Power Cutter Machine		4
Power Hacksaw Machine		3
Shearing Machine		1
Bending Machine		1

INNOVATIVE ENGINEERING SOLUTIONS

OUR WORKSHOP- MACHINERY LIST



Description	Capacity	Quantity
Pipe Rolling Machine	Max Ø 2"Pipe rolling	1
Welding Plants		14
Pipe Bending Machine	1/2" to 4"	1
Nibbling Machine	15-30 Ton	1
Milling Machine	Length 45"	1
Lathe Machine		1

INNOVATIVE ENGINEERING SOLUTIONS

OUR WORKSHOP- MACHINERY LIST



Description	Capacity	Quantity
Radial Drill Machine	3/8" to,8"Hole	1
Fix Drill Machine	5mm-42mm dia	1
Magnet Drill Machine	Max 25mm Hole	2
CNC Machine (Plate Holling)	Holling Max 12 To, 23mm	1
Shaper Machine		2
Surface Grinder Machine		1

INNOVATIVE ENGINEERING SOLUTIONS

OUR WORKSHOP- MACHINERY LIST



Description	Capacity	Quantity
Table Grinder Machine		1
Air Compressor	5-20 bar	2
Deisel Generator	35-310KVA	1

OUR WORKSHOP



INNOVATIVE ENGINEERING SOLUTIONS

OUR WORKSHOP



INNOVATIVE ENGINEERING SOLUTIONS

OUR WORKSHOP



INNOVATIVE ENGINEERING SOLUTIONS

OUR WORKSHOP



INNOVATIVE ENGINEERING SOLUTIONS

OUR WORKSHOP



INNOVATIVE ENGINEERING SOLUTIONS

OUR WORKSHOP



INNOVATIVE ENGINEERING SOLUTIONS

OUR WORKSHOP



INNOVATIVE ENGINEERING SOLUTIONS

OUR WORKSHOP



INNOVATIVE ENGINEERING SOLUTIONS

OUR WORKSHOP



INNOVATIVE ENGINEERING SOLUTIONS

OUR WORKSHOP



INNOVATIVE ENGINEERING SOLUTIONS

OUR WORKSHOP



INNOVATIVE ENGINEERING SOLUTIONS

PROJECTS

CHEMTEC LLC
Innovative Engineering Solutions



**Big Tex Sand Screen CTB 250 that allows for continuous operation while providing maintenance. Built utilizing the Texas Giant Sand Screen technology.
2 Leg – 2 Phase Screen with configurations of 100 mesh with a 200 mesh or 100 mesh with a 250 mesh.**

INNOVATIVE ENGINEERING SOLUTIONS

PROJECTS



SAND SCREENS

INNOVATIVE ENGINEERING SOLUTIONS

PROJECTS



SKID MOUNTED SEPARATOR

INNOVATIVE ENGINEERING SOLUTIONS

PROJECTS



SKID MOUNTED TEST SEPARATOR

INNOVATIVE ENGINEERING SOLUTIONS

PROJECTS



PRESSURE VESSEL OF DIFFERENT CAPACITIES

INNOVATIVE ENGINEERING SOLUTIONS

PROJECTS



VESSEL

INNOVATIVE ENGINEERING SOLUTIONS

PROJECTS



HORIZONTAL VAPOR RECOVERY VESSEL

INNOVATIVE ENGINEERING SOLUTIONS

PROJECTS



FIRE TUBE VESSELS

PROJECTS



OIL SEPARATORS WITH COMPRESSOR AND MOTOR STRUCTURES ON TOP

INNOVATIVE ENGINEERING SOLUTIONS

PROJECTS



CRUDE OIL EXCHANGERS



CERTIFICATIONS

The American Society of Mechanical Engineers



CERTIFICATE OF AUTHORIZATION

The named company is authorized by The American Society of Mechanical Engineers (ASME) for the scope of activity shown below in accordance with the applicable rules of the ASME Boiler and Pressure Vessel Code. The use of the ASME Single Certification Mark and the authority granted by this Certificate of Authorization are subject to the provisions of the agreement set forth in the application. Any construction stamped with the ASME Single Certification Mark shall have been built strictly in accordance with the provisions of the ASME Boiler and Pressure Vessel Code.

COMPANY:

CHEMTED LLC
981 N HWY TX-174
Rio Vista, Texas 76093
United States

SCOPE:

Manufacture of pressure vessels at the above location and field sites controlled by the above location (This authorization does not cover impregnated graphite)

AUTHORIZED: March 06, 2023

EXPIRES: February 17, 2026

CERTIFICATE NUMBER: 58542

Board Chair, Conformity Assessment

Managing Director, Standards & Engineering Services



CERTIFICATE OF AUTHORIZATION

The named company is authorized by The American Society of Mechanical Engineers (ASME) for the scope of activity shown below in accordance with the applicable rules of the ASME Boiler and Pressure Vessel Code. The use of the ASME Single Certification Mark and the authority granted by this Certificate of Authorization are subject to the provisions of the agreement set forth in the application. Any construction stamped with the ASME Single Certification Mark shall have been built strictly in accordance with the provisions of the ASME Boiler and Pressure Vessel Code.

COMPANY:

CHEMTED LLC
981 N HWY TX-174
Rio Vista, Texas 76093
United States

SCOPE:

Manufacture of Class 1 and Class 2 pressure vessels at the above location and field sites controlled by the above location

AUTHORIZED: February 17, 2023

EXPIRES: February 17, 2026

CERTIFICATE NUMBER: 60659

Board Chair, Conformity Assessment

Managing Director, Standards & Engineering Services



CHEMTED LLC
Innovative Engineering Solutions



INNOVATIVE ENGINEERING SOLUTIONS

CERTIFICATIONS

CHEMTED LLC
Innovative Engineering Solutions

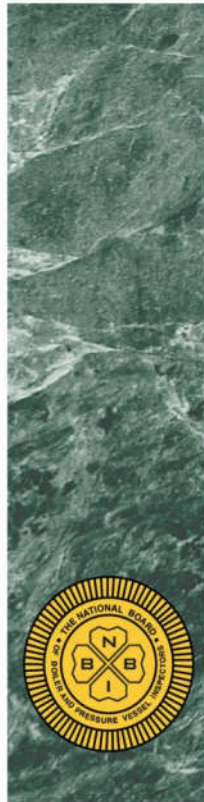

THE NATIONAL BOARD
OF
BOILER & PRESSURE VESSEL INSPECTORS

Certificate of Authorization



This is to certify that
CHEMTED LLC
981 N HWY TX-174
Rio Vista, Texas 76093
United States

is authorized to use the R Symbol in accordance with the provisions of the National Board Inspection Code and NB-415, Accreditation of "R" Repair Organizations.

All activities within the scope of this Authorization shall be controlled by the above location.
The scope of this Authorization is limited to:

Metallic
Repairs and Alterations
At
Shop and Field Locations



Certification Number: 11333

Issue Date: March 6, 2023

Expiration Date: February 17, 2026

Executive Director



THE NATIONAL BOARD
OF
BOILER & PRESSURE VESSEL INSPECTORS

Certificate of Authorization to Register



This is to certify that

CHEMTED LLC
981 N HWY TX-174
Rio Vista, Texas 76093
United States

is authorized to apply the "NB" mark and register boilers, pressure vessels or other pressure retaining items with the National Board.

The scope of Authorization is limited to items manufactured in accordance with:

ASME Designator(s): U, U2

Issue Date: March 6, 2020

Revision Date: February 17, 2023

This Certificate of Authorization to Register will remain in effect as long as the manufacturing organization holds a valid Certificate of Authorization issued by the American Society of Mechanical Engineers.

Executive Director

INNOVATIVE ENGINEERING SOLUTIONS

CERTIFICATIONS



REGISTRATIONS



We design, fabricate and supply our equipment and other engineering systems according to Canadian Registration (CRN), Tubular Exchangers Manufacturers Association (TEMA) Standard, API 660 and PD 5500.



CONTACT US



CHEMTED LLC

Email: info@chemted.com

Website: www.chemted.com

Phone: +1 214 680 6013

**981 N HWY TX-174 Rio Vista,
Texas - 76063 United States**

INNOVATIVE ENGINEERING SOLUTIONS